

Operational Amplifier, Monolithic, 2 Amplifier, 500 kHz, 0.15 V/ $\mu$ s,  $\pm 3$ V to  $\pm 20$ V, DIP, 8 Pins

Manufacturers	<a href="#">Analog Devices, Inc</a>
Package/Case	CDIP-8
Product Type	Amplifier ICs
RoHS	
Lifecycle	

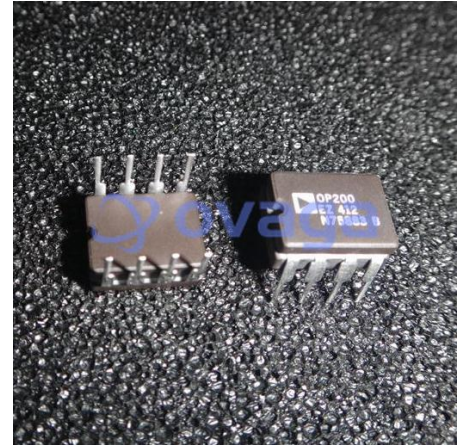

Images are for reference only

Please submit RFQ for OP200EZ or [Email to us: sales@ovaga.com](mailto:sales@ovaga.com) We will contact you in 12 hours.

[RFQ](#)

## General Description

The OP200 is the first monolithic dual operational amplifier to offer OP77 type precision performance. Available in the industry standard 8-lead pinout, the OP200 combines precision performance with the space and cost savings offered by a dual amplifier.

The OP200 features an extremely low input offset voltage of less than 75  $\mu$ V with a drift below 0.5  $\mu$ V/ $^{\circ}$ C, guaranteed over the full military temperature range. Open-loop gain of the OP200 exceeds 5,000,000 into a 10 k $\Omega$  load; input bias current is under 2 nA; CMRR is over 120 dB; and PSRR is below 1.8  $\mu$ V/V. On-chip Zener zap trimming is used to achieve the extremely low input offset voltage of the OP200 and eliminates the need for offset pulling.

Power consumption of the OP200 is low, with each amplifier drawing less than 725  $\mu$ A of supply current. The total current drawn by the dual OP200 is less than one-half that of a single OP07, yet the OP200 offers significant improvements over this industry-standard op amp. The voltage noise density of the OP200, 11 nV/ $\sqrt$ Hz at 1 kHz, is half that of most competitive devices.

The OP200 is an ideal choice for applications requiring multiple precision op amps and where low power consumption is critical.

For a quad precision op amp, see the OP400.

## Features

Low input offset voltage: 75  $\mu\text{V}$  maximum

Low offset voltage drift, over  $-55^{\circ}\text{C} < \text{TA} < +125^{\circ}\text{C}$

0.5  $\mu\text{V}/^{\circ}\text{C}$  maximum

Low supply current (per amplifier): 725  $\mu\text{A}$  maximum

High open-loop gain: 5000 V/mV minimum

Low input bias current: 2 nA maximum

Low noise voltage density: 11 nV/ $\sqrt{\text{Hz}}$  at 1 kHz

Stable with large capacitive loads: 10 nF typical

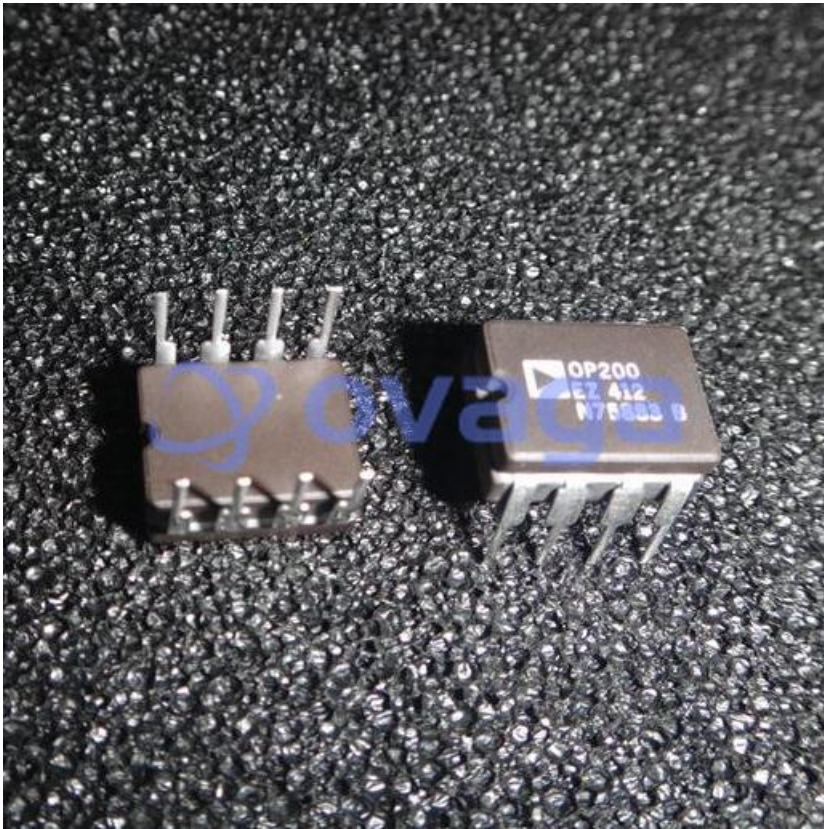

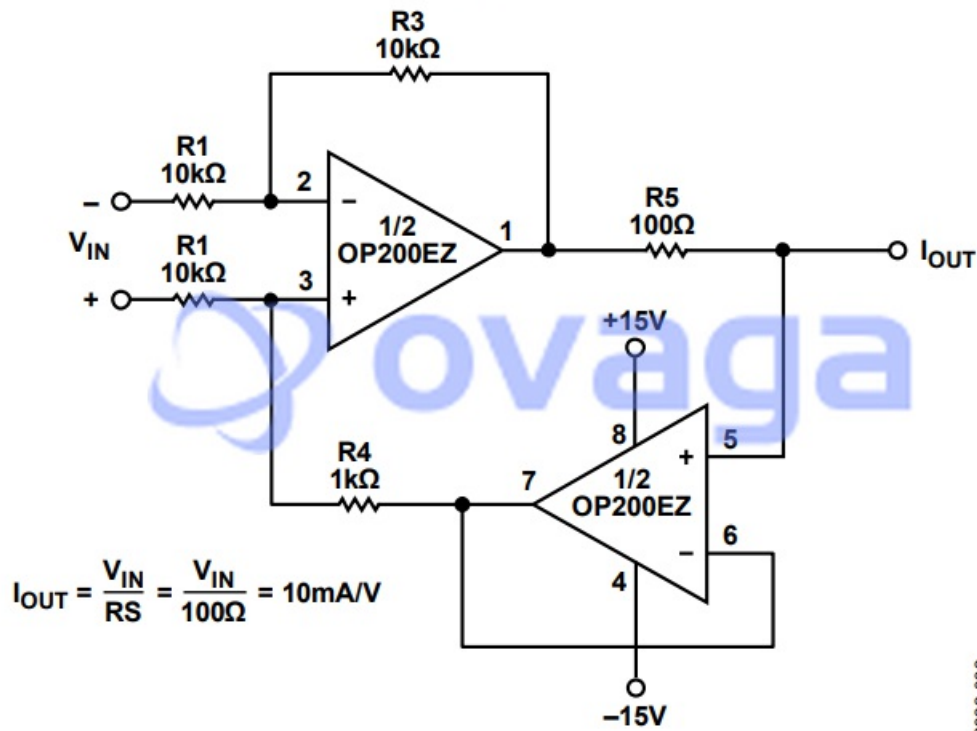

00322-032

## Related Products

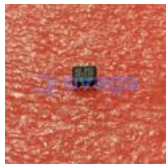

### [OP213F](#)

Analog Devices, Inc  
SMD/DIP-8/SOP-8

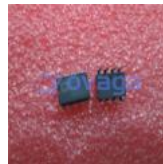

### [OP42AZ](#)

Analog Devices, Inc  
CDIP-8

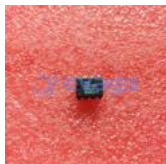

### [OP27GP](#)

Analog Devices, Inc  
PDIP-8

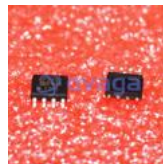

### [OP37GS](#)

Analog Devices, Inc  
SOIC-8



### [OP462GSZ](#)

Analog Devices, Inc  
SOIC-14



### [OP2177ARM](#)

Analog Devices, Inc  
MSOP8



### [OP467GPZ](#)

Analog Devices, Inc  
PDIP-14



### [OP400GPZ](#)

Analog Devices, Inc  
PDIP-14